

# CLASSIC LINE

**MODELLI A PEDANE PIANE**  
**MODELS WITH FLAT PLATFORMS**  
**MODELES AVEC CHEMINS DE ROULEMENT NUS**  
**MODELLE MIT FLACHEN FAHRSCHEIENEN**

**3500**  
**4000**  
**4500** **KG**

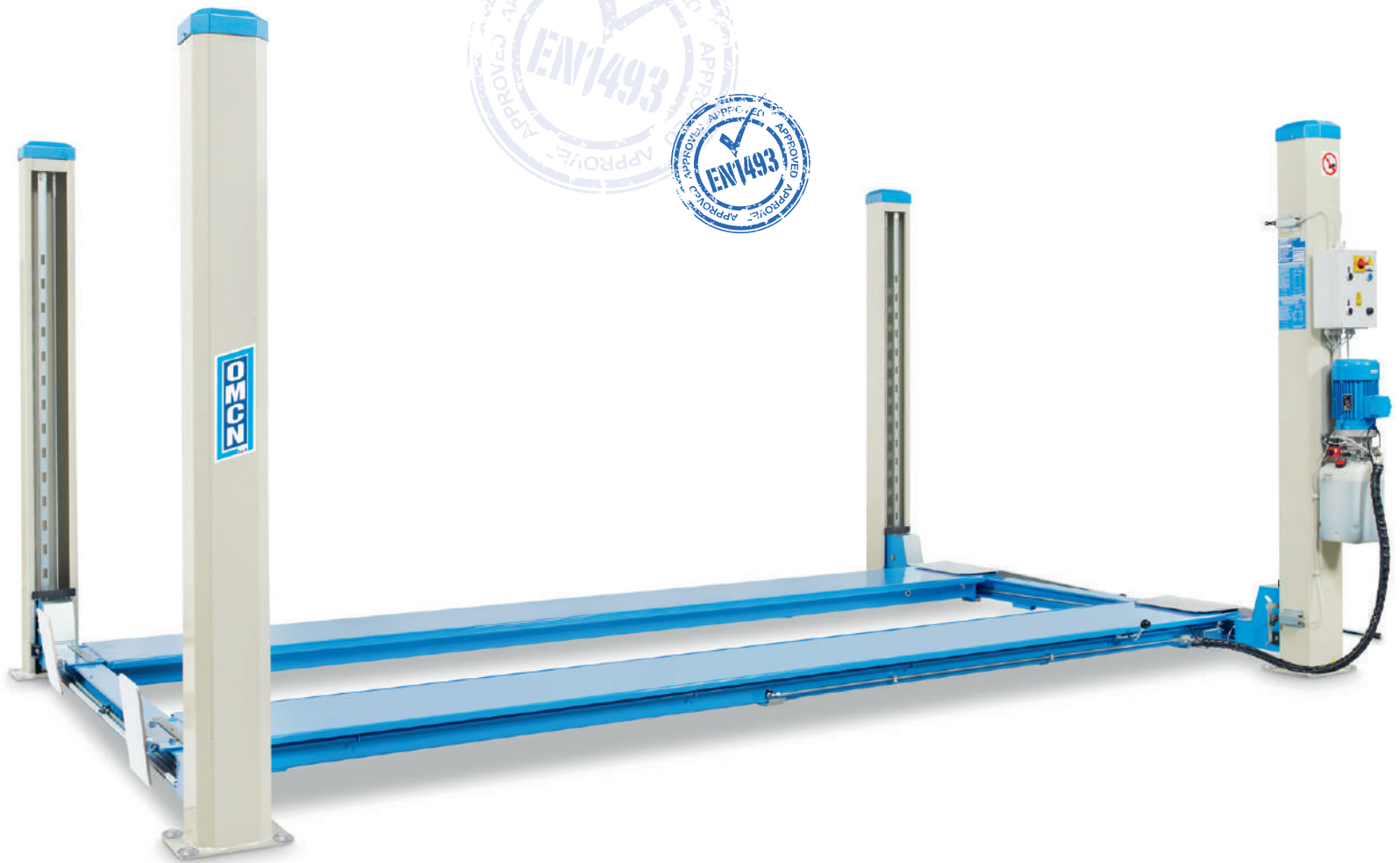

ART. 401

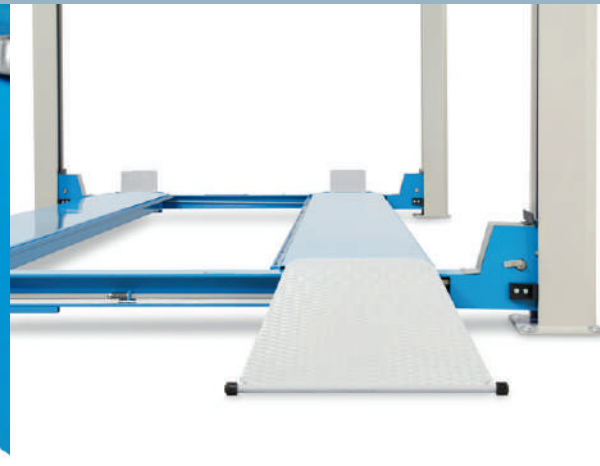
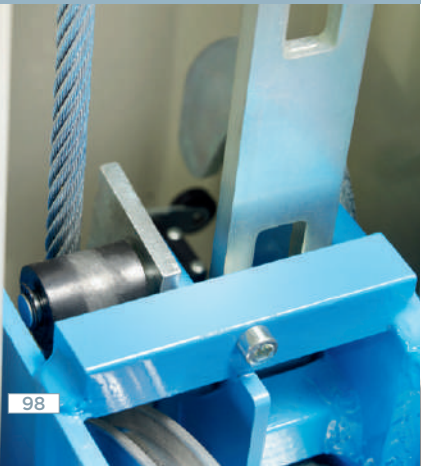

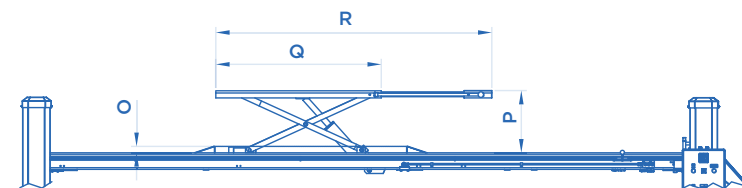
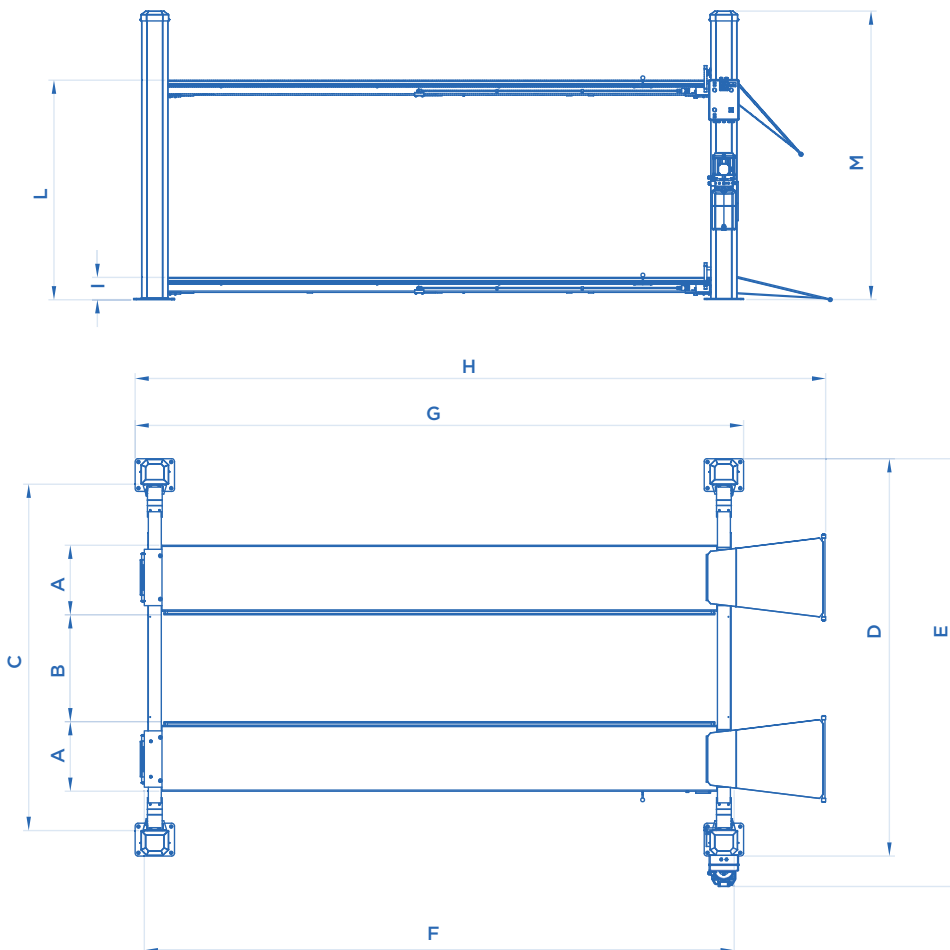



ART.	 LIFT TABLE	 O mm	 P mm	 Q mm	 R mm
401/I	3000 Kg	50	450	1400	2000

 Potenza motore • Motor power  
Puissance moteur • Motorleistung

**OPTIONAL** Pag. 106

ART.			Motore trifase Three-phase motor Moteur triphasé Netzspannung	 A mm	 B mm	 C mm	 D mm	 E mm	 F mm	 G mm	 H mm	 I mm	 L mm	 M mm	 KG	
<b>399</b>	3500 Kg	2,2 Kw	400V • 50HZ	380	MIN	MAX	2400	2780	3050	<b>4200</b>	4340	4950	160	1700	2200	1000
<b>400</b>				500	820	1100	2650	3030	3300	<b>4500</b>	4640	5250	160	1800	2200	1100
<b>400/L</b>				600	720	1000	2650	3030	3300	<b>5000</b>	5140	5750	160	1800	2200	1270
<b>401</b>	4000 Kg	3,3 Kw		500	820	1100	2650	3030	3300	<b>4500</b>	4640	5250	160	1800	2200	1170
<b>401/I</b>				500	820	1100	2650	3030	3300	<b>4500</b>	4640	5250	160	1700	2200	1420
<b>401/L</b>				600	720	1000	2650	3030	3300	<b>5000</b>	5140	5750	160	1800	2200	1340
<b>401/LS</b>			4500 Kg	600	720	1000	3000	3380	3650	<b>5000</b>	5140	5750	160	1800	2200	1410